











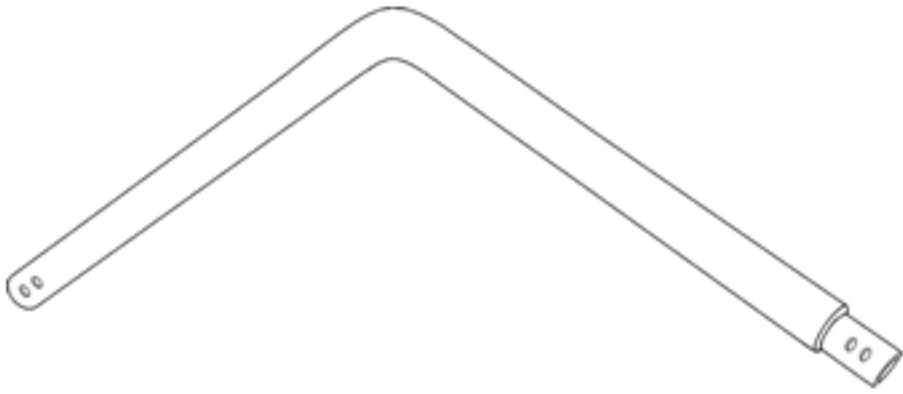
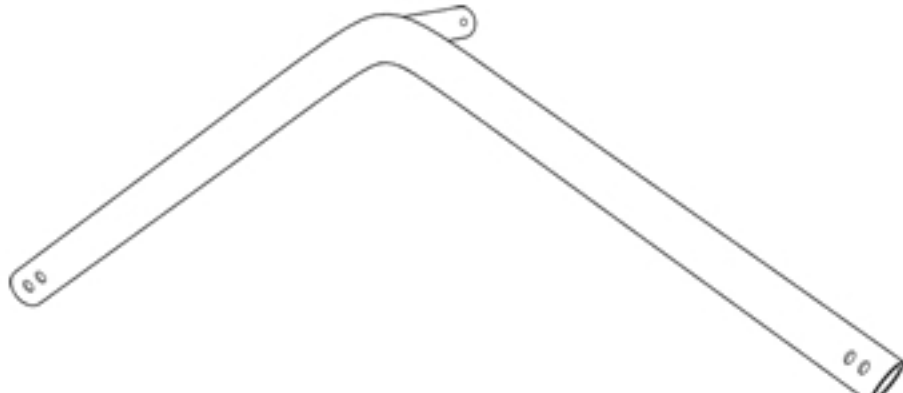
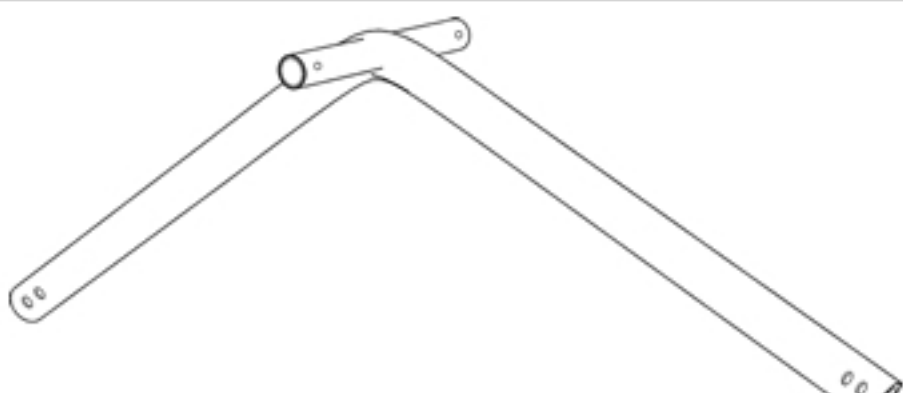

















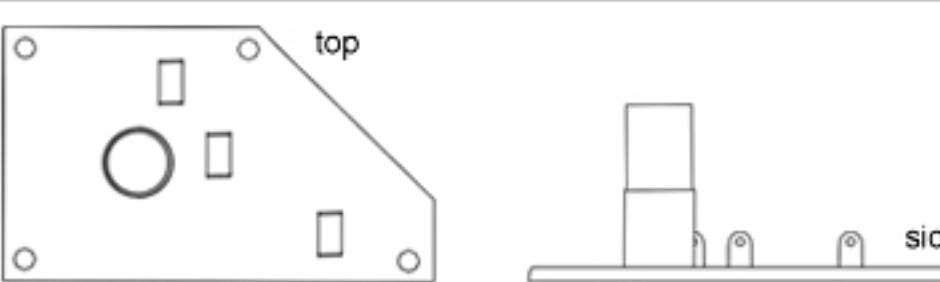
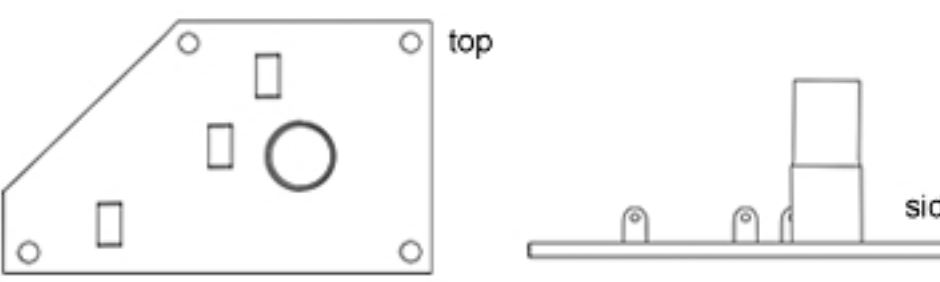









Name	No.	Picture	9 x 8	9 x 12
Tube 78mm	1		24	32
Tube 78mm	1B		10	14
Roof/wall corner connector 78mm	2		10	14
Front/end connector 78mm	3		2	2
Middle connector 78mm	3A		3	5
Roof reinforcement 38mm	4		15	21
Roof reinforcement 38mm	5		10	14
Entrance reinforcement 78mm	6		4	4
Entrance reinforcement 78mm	7		4	4
Roof reinforcement 38mm	8		5	7
Horizontal entrance reinforcement 38mm	9A		4	4
Horizontal entrance reinforcement 38mm	9B		4	4
Peak roof tube 50mm	10		4	6

Name	No.	Picture	9 x 8	9 x 12
Cross roof tube 50mm	11		8	8
Cross roof tube 50mm	12		24	40
Wall reinforcement 38mm	13		4	4
Wall reinforcement 38mm	14		4	4
Bottom gate reinforcement 38mm	15		4	4
Bottom gate reinforcement 38mm	16B		4	4
Tube coming through the roof tarpaulin	17		6	10
Tube coming through the roof tarpaulin	18		2	2
Tube coming through the entrance tarpaulin 25mm	19		8	8
Tube coming through the entrance tarpaulin 25mm	20		4	4
Left foot	A		2	2
Right foot	B		2	2
Middle foot on the entrance	C		4	4
Middle foot on the sides	D		6	10

Name	No.	Picture	9 x 8	9 x 12
Screw M10x90			124	164
Screw M10x140			40	56
Screw M10x60			10	14
Screw M10x50			30	34
Screw M10x40			4	4
Screw M8x70			14	18
Screw M6x30			6	6
Rod			14	18
Single reel for the entrance			4	4
Double reel for the entrance			2	2
Buckle for the feet		 front  side	14	18
Belt			10	14
Strings 4 x 15m (entrance & roof) 4 x 7m (entrance & entrance frame) 6 x 4m (entrance & entrance frame reinforcement) 2 x 22m (gate lift)				
Ball with rubber (to fix the small entrance)			4	4
Plug			16	16

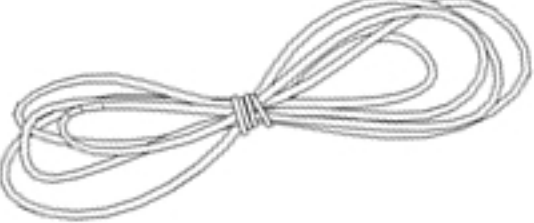
Distribute feet on leveled ground keeping distances as pictured.
For the tents with length above 12m base constructions (9x8m or 9x12m) should be assembled first.
Next, gently move one to the other as pictured.

9m x 16m

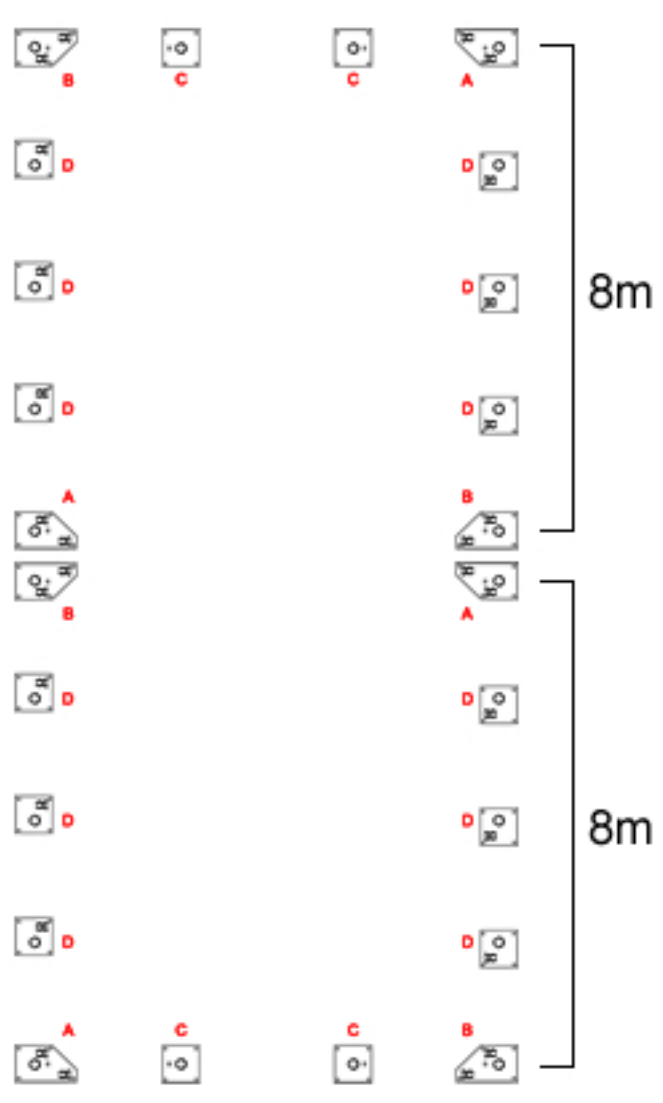

9m x 20m

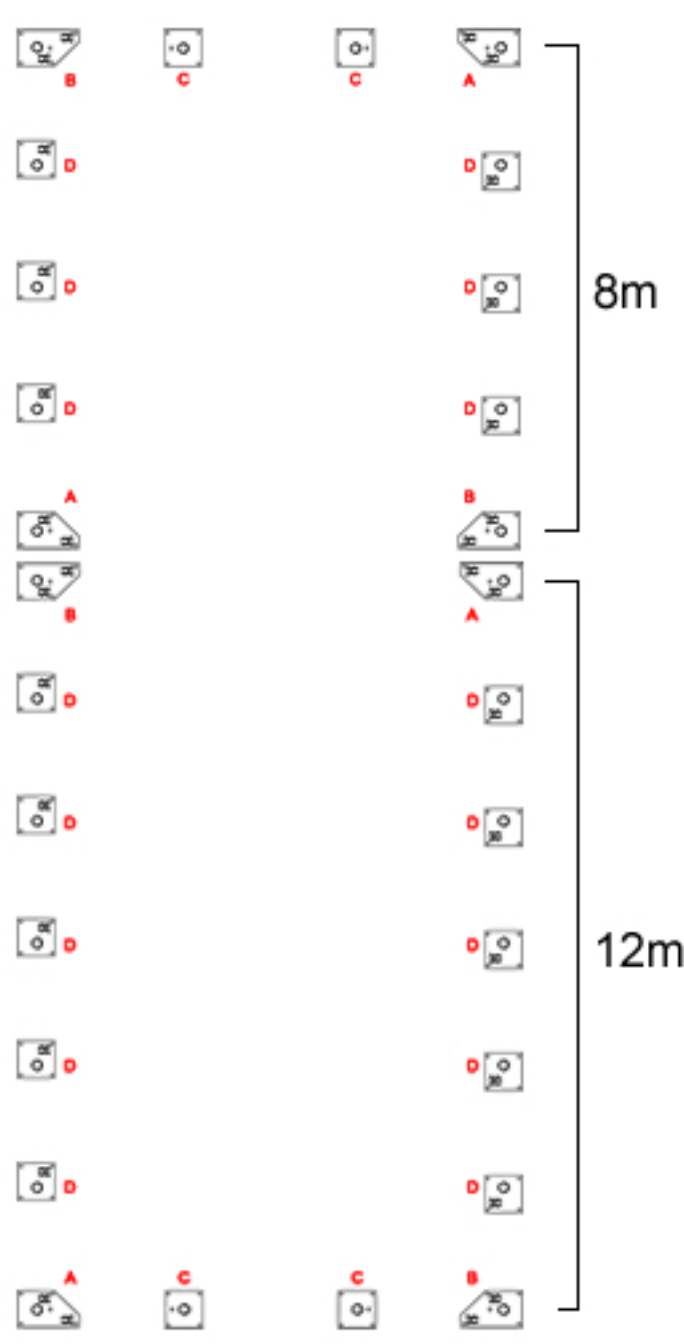

9m x 24m

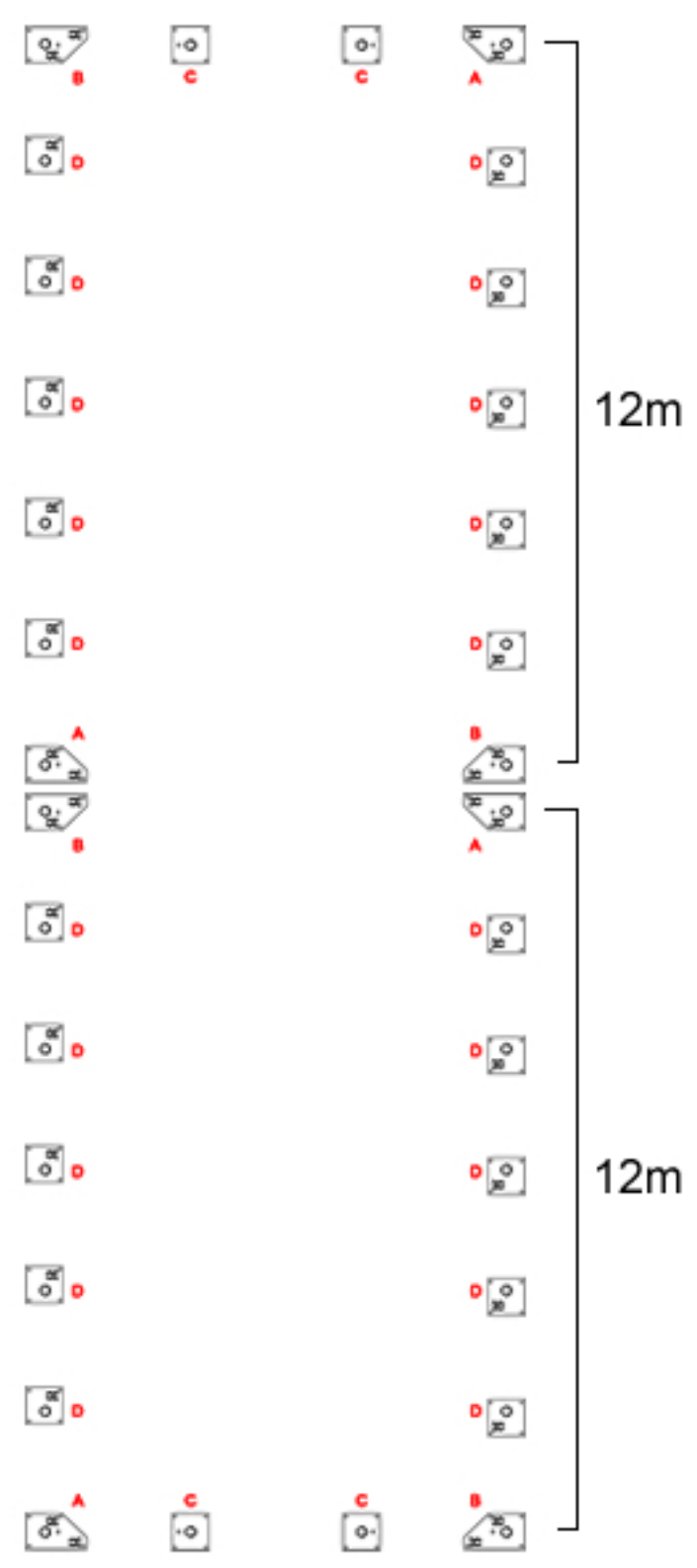

Distribute feet on leveled ground keeping distances as pictured.
For the tents with length above 12m base constructions (9x8m or 9x12m) should be assembled first.
Next, gently move one to the other as pictured.

9m x 28m



9m x 32m

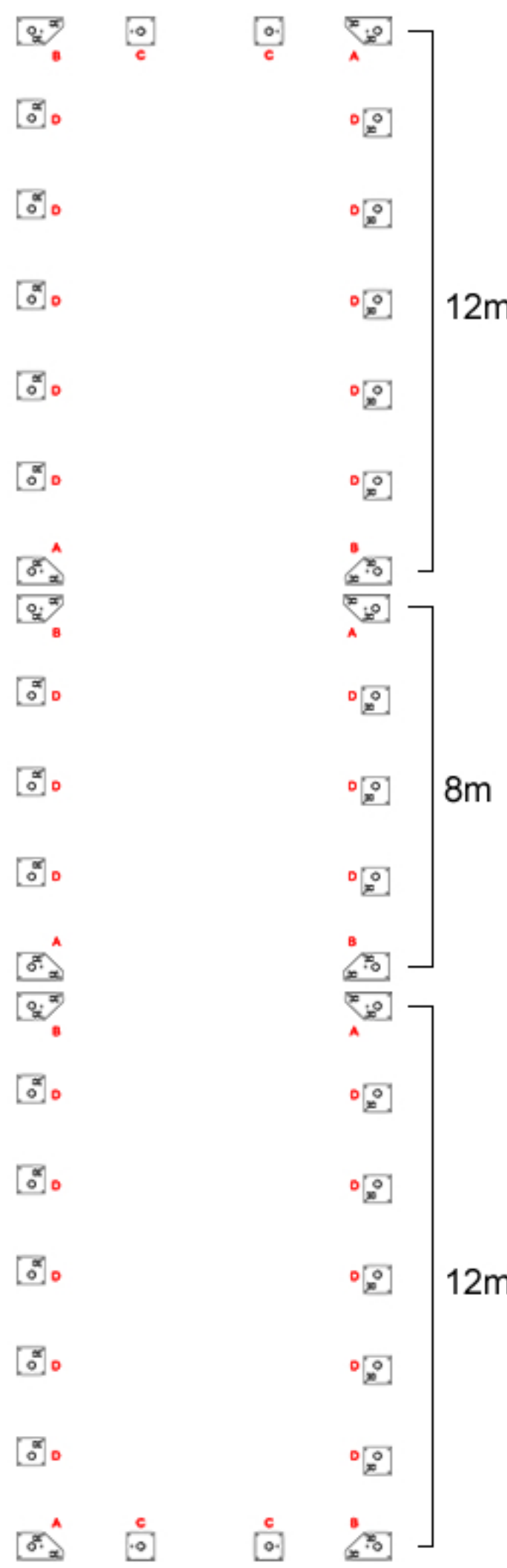

9m x 40m

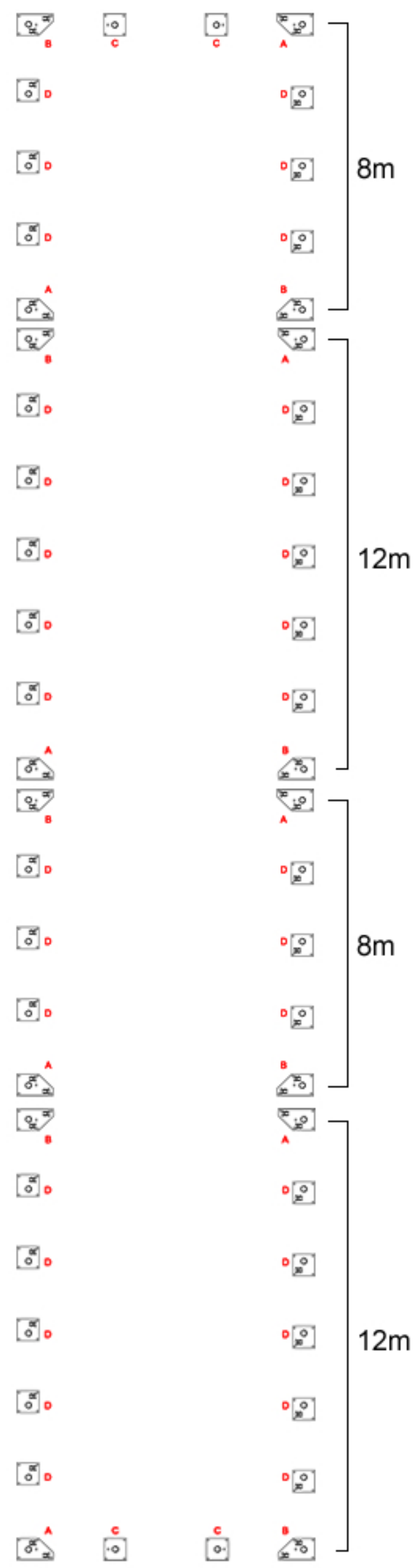

Distribute feet on leveled ground keeping distances as pictured.

For the tents with length above 12m base constructions (9x8m or 9x12m) should be assembled first.

Next, gently move one to the other as pictured.

9m x 44m

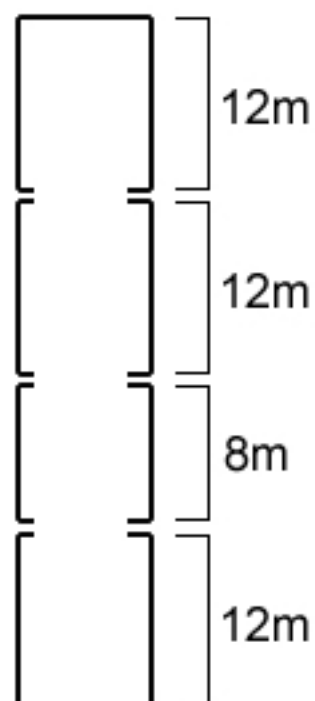

9m x 48m

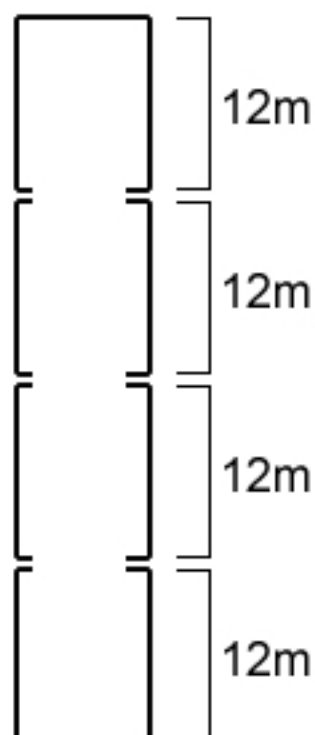

9m x 52m

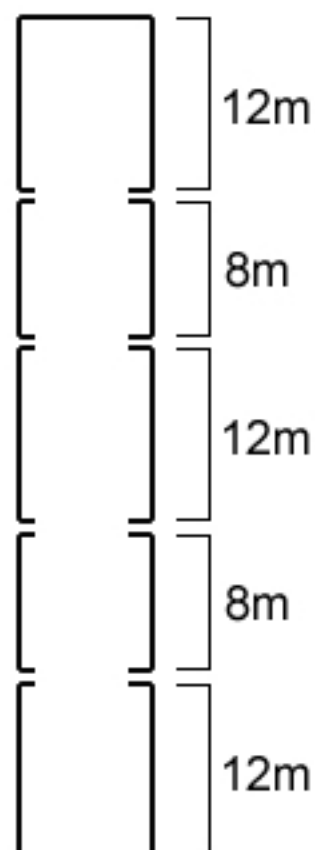

9m x 56m

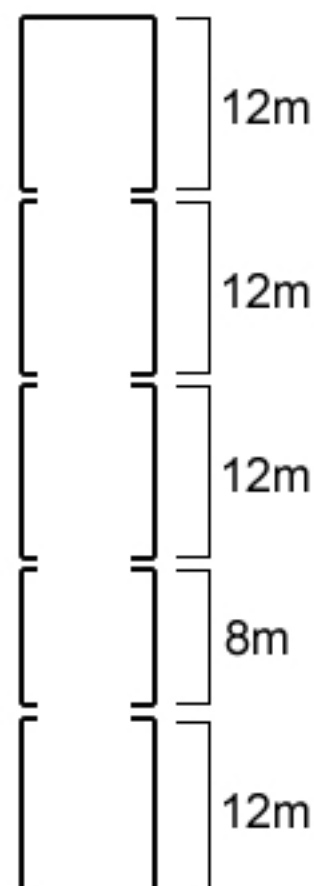

9m x 60m

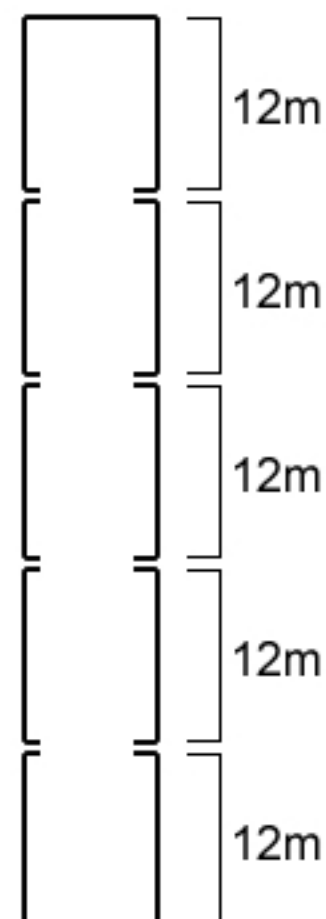

Fix the feet to the ground using the rods. The rods should criss-cross.

Manner in which tent is fixed to the ground should be regularly monitored in order to assure the security of the tent.

Attaching the tent to the ground correctly prolongs the durability of its components and the tent's construction as a whole.

Fix the buckle to the corresponding feet.

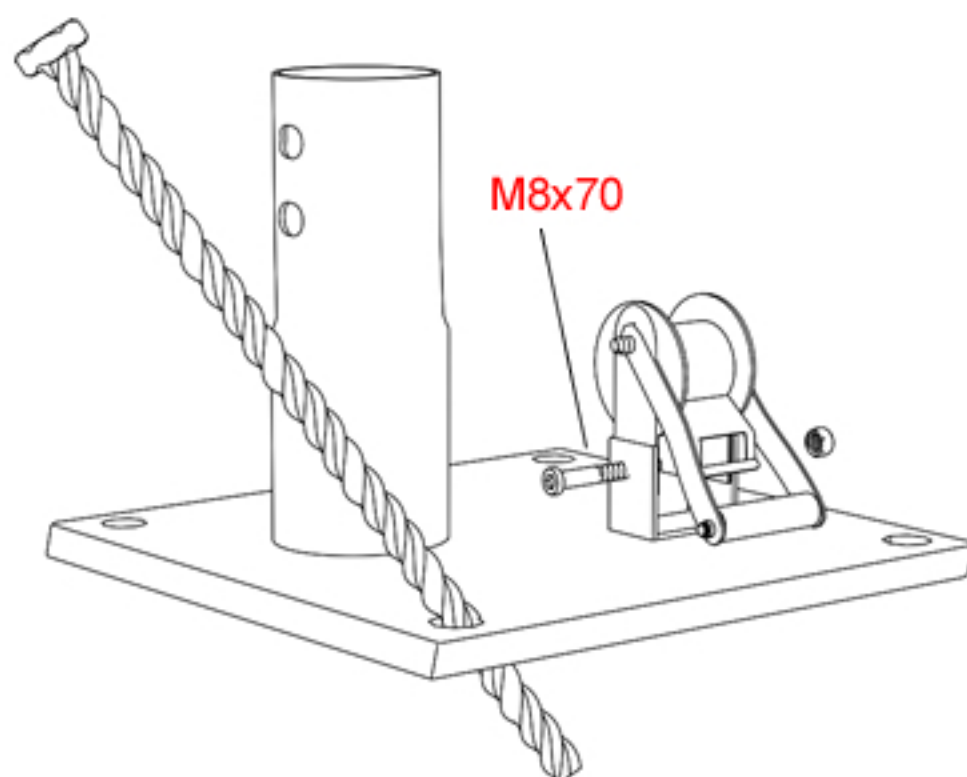

STEP 2

Connect tubes using the screws as shown on the picture. Make sure all the screws fit tightly.

Front and back entrance

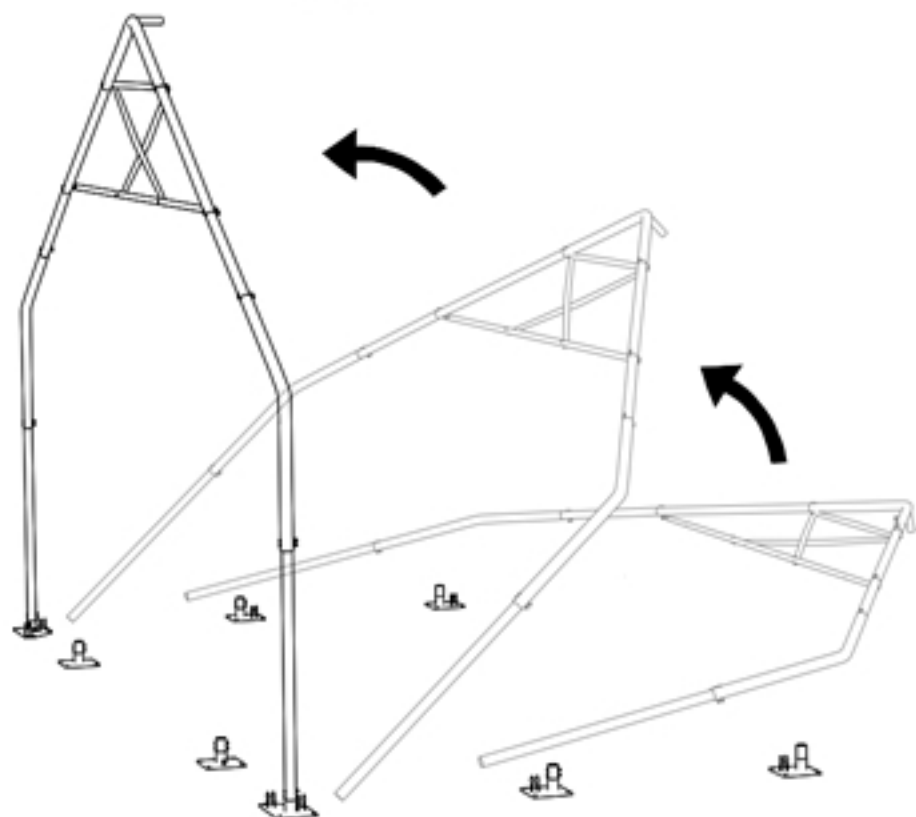
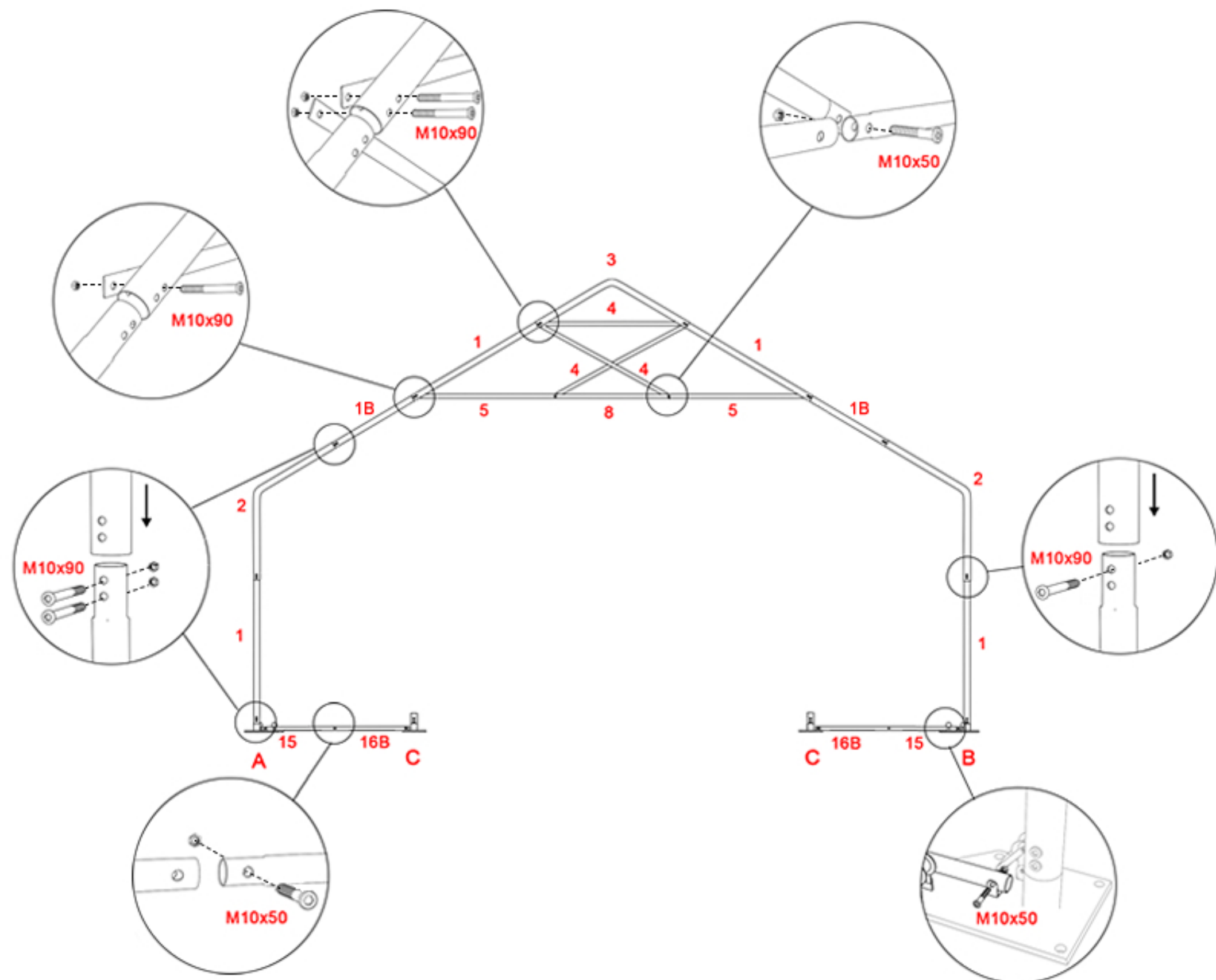

Assemble individual frames according to the pictures, fixing them after they are mounted to the feet.
Make sure every foot is fixed to the ground first.

STEP 3

Connect outer tubes and roof reinforcements using the screws.
Repeat for the following extensions.

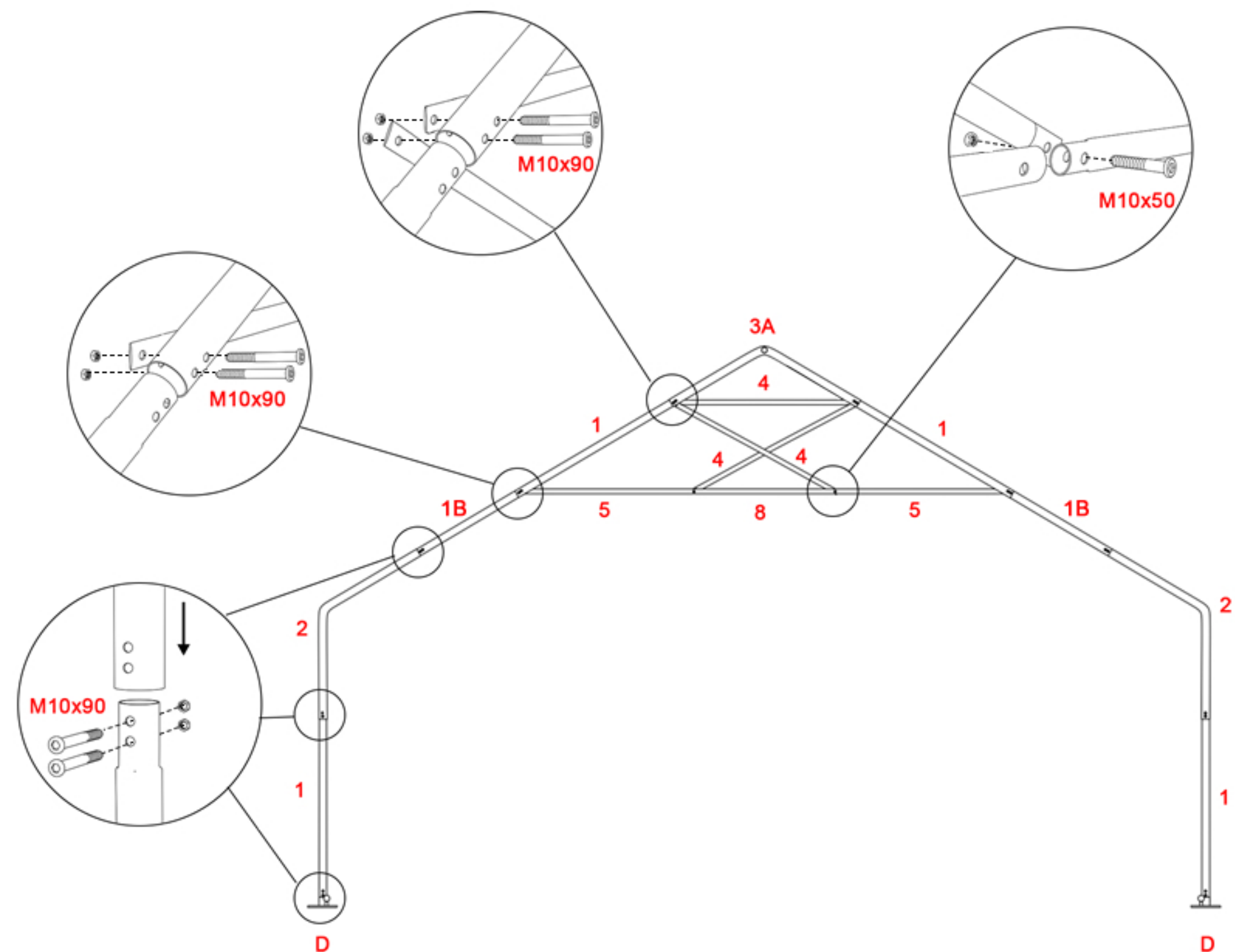
Inner frame

KROK 4

Connect all the frames using tubes.
Diagonal side wall reinforcement should be placed in the first and second panel.

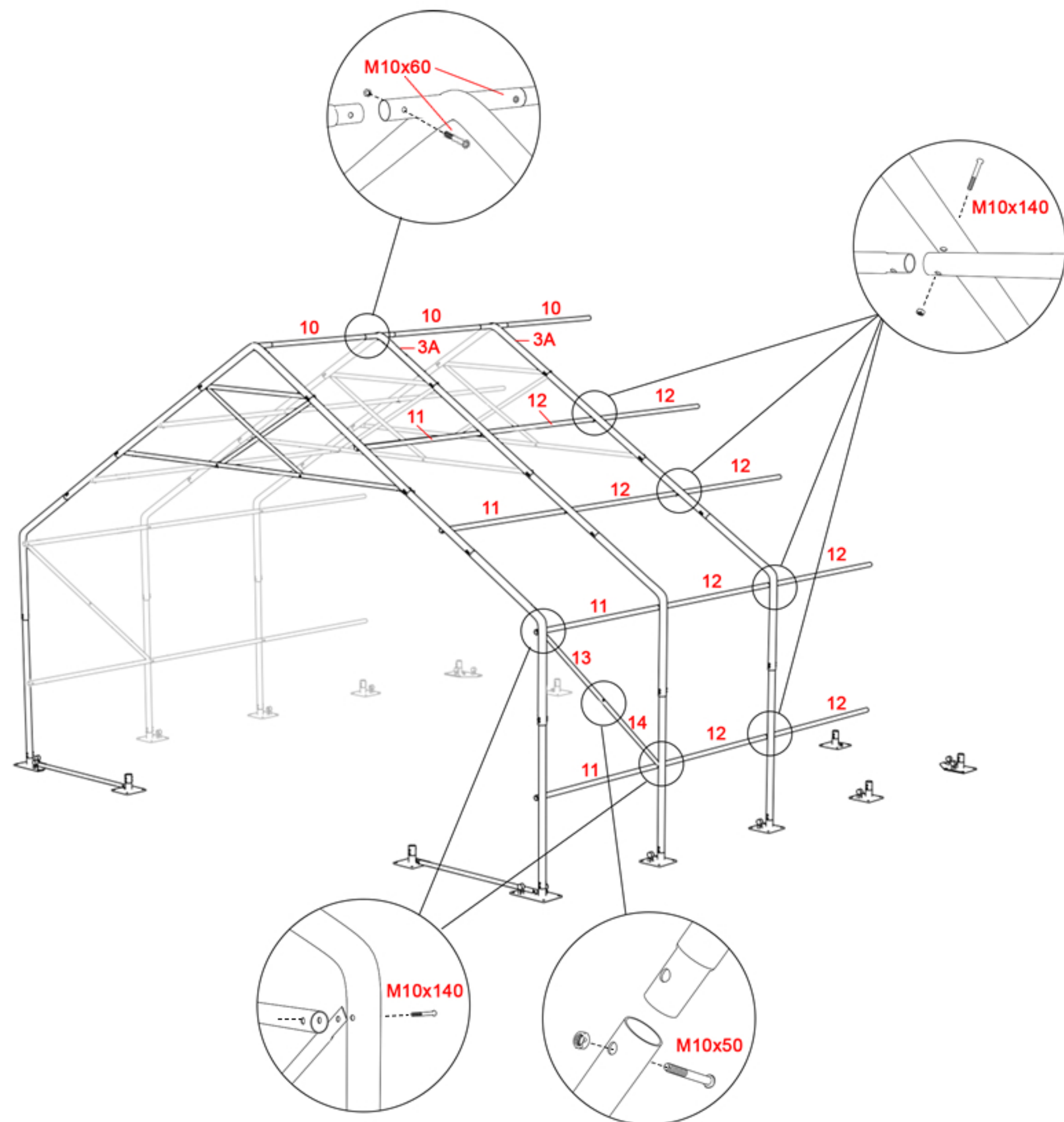

STEP 5

On the front and back frame mount entrance gate tubes. On the top tube fit reels (double reel on one side, one single reel in the middle and second on the other side)

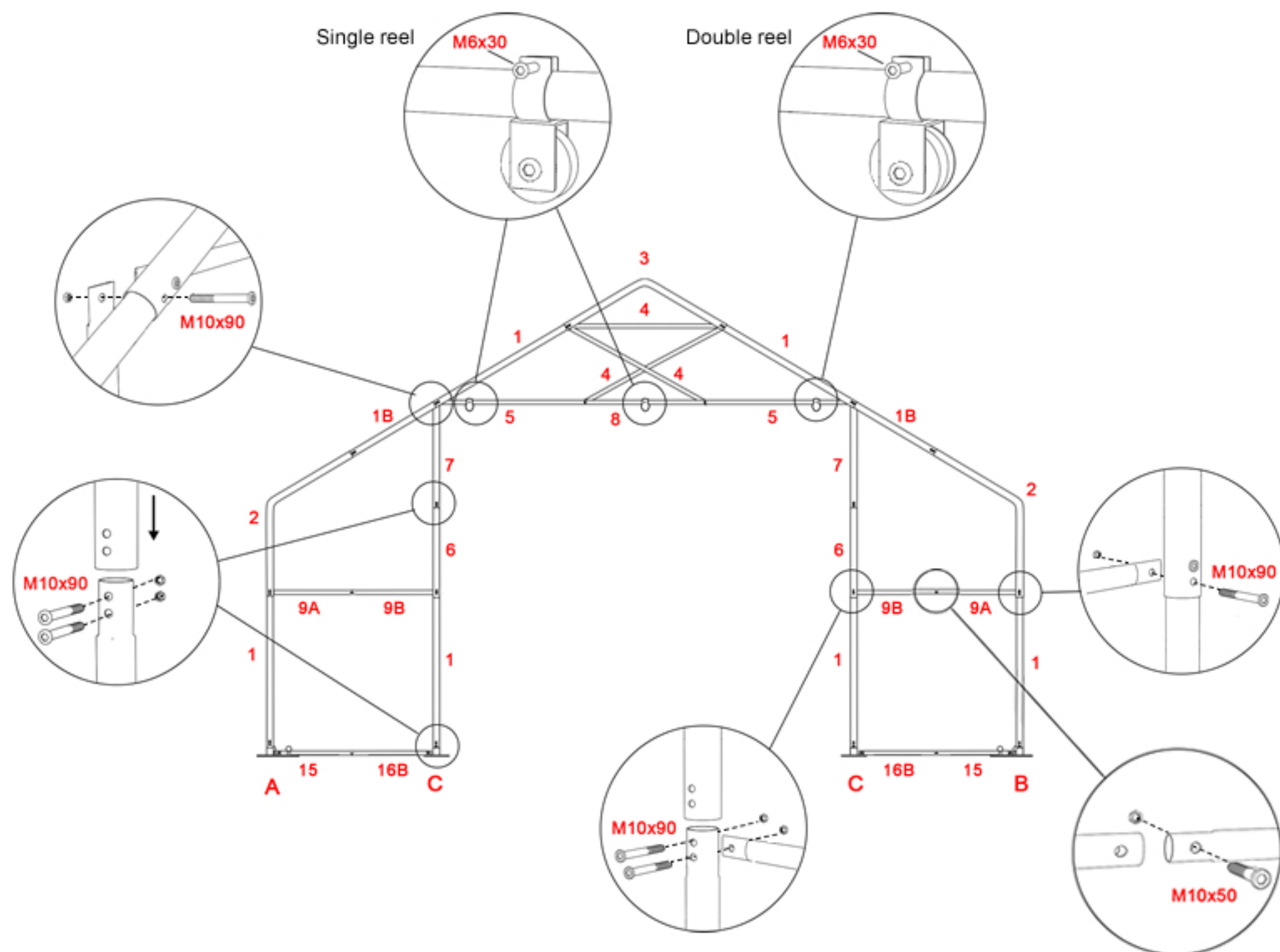

For constructions longer than 12m entrance gate should not be mounted between main tents' links.

Assembled 9x8m construction

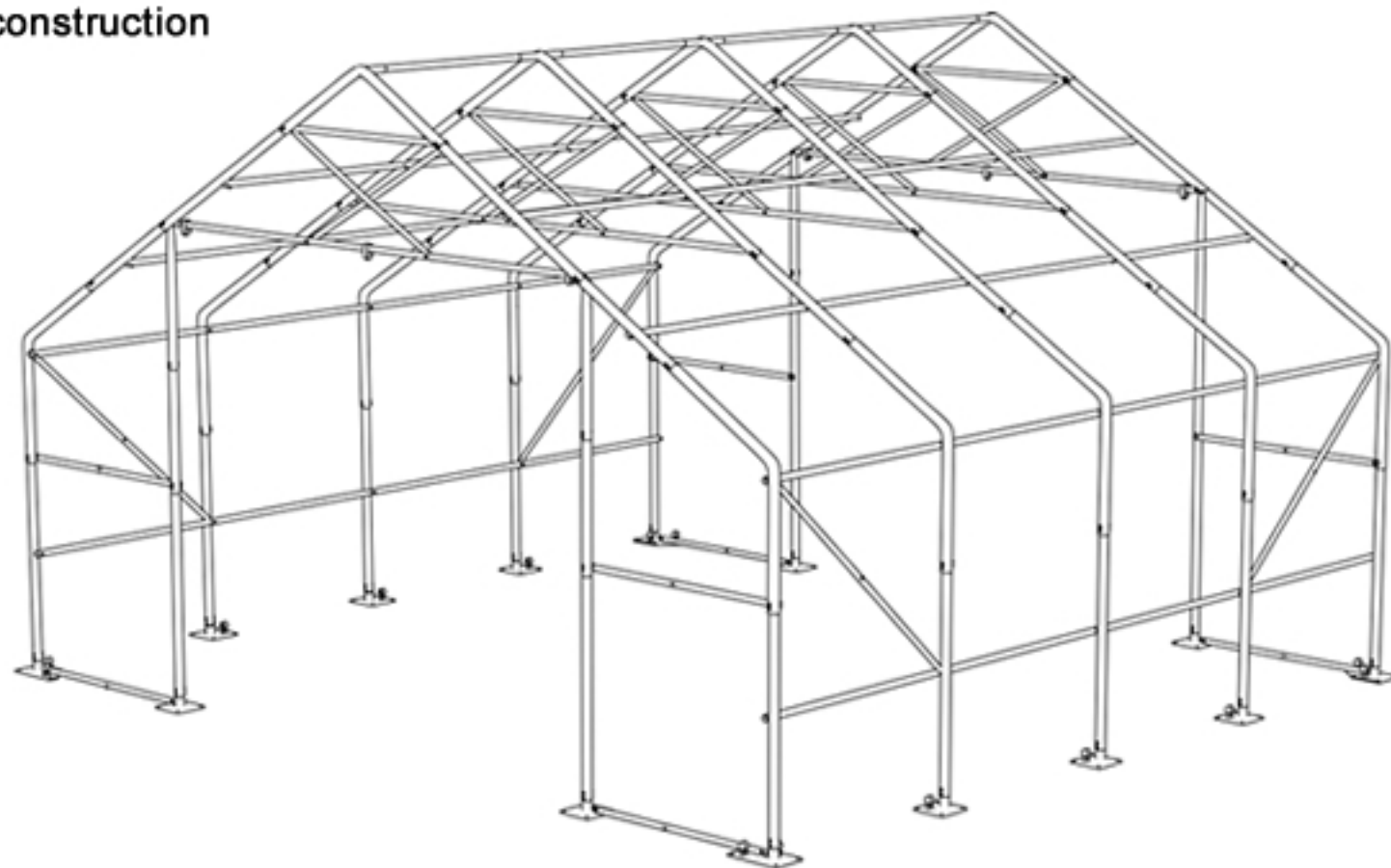

Assembled 9x12m construction

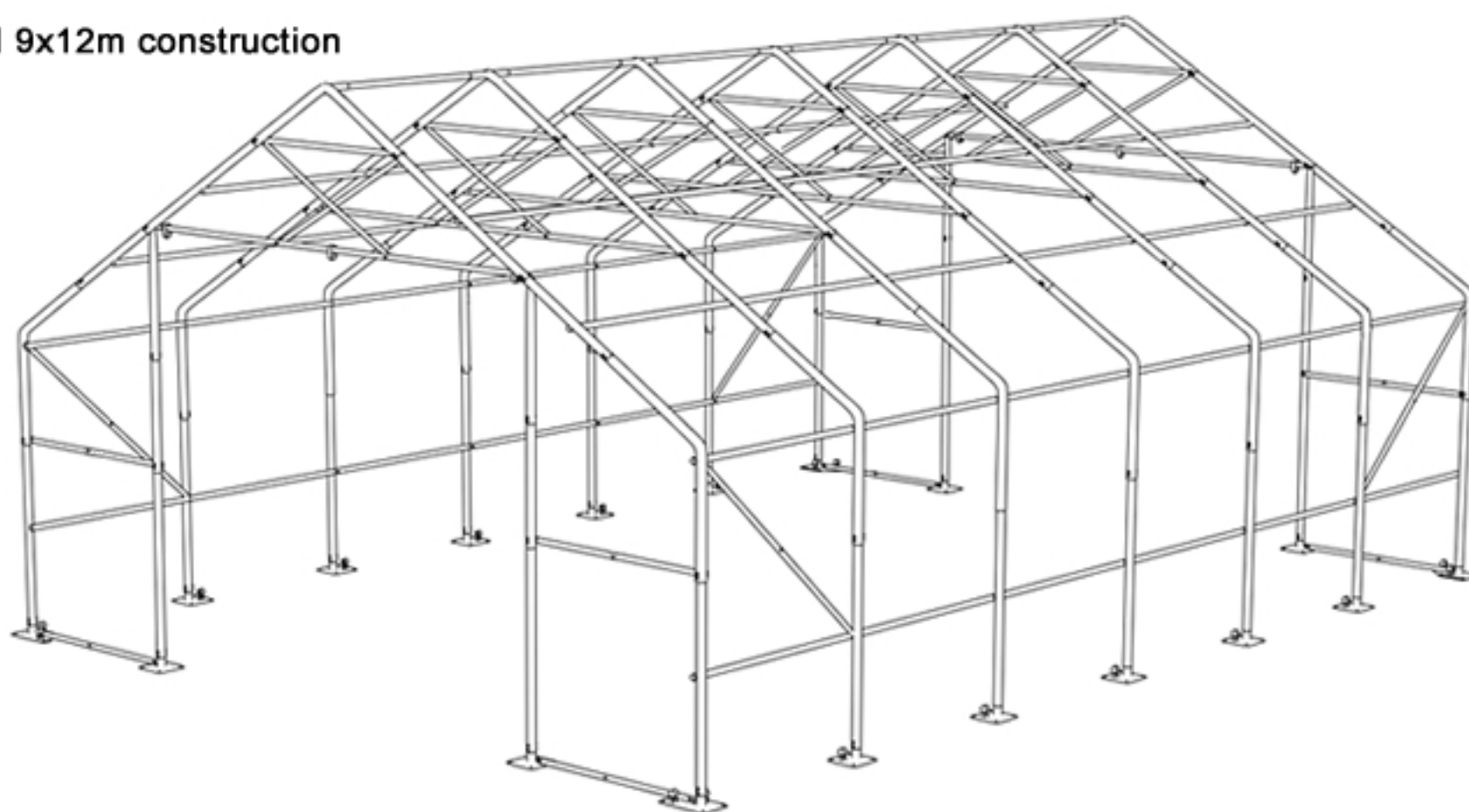

Assembled 9x16 construction (Two 9x8m constructions linked)

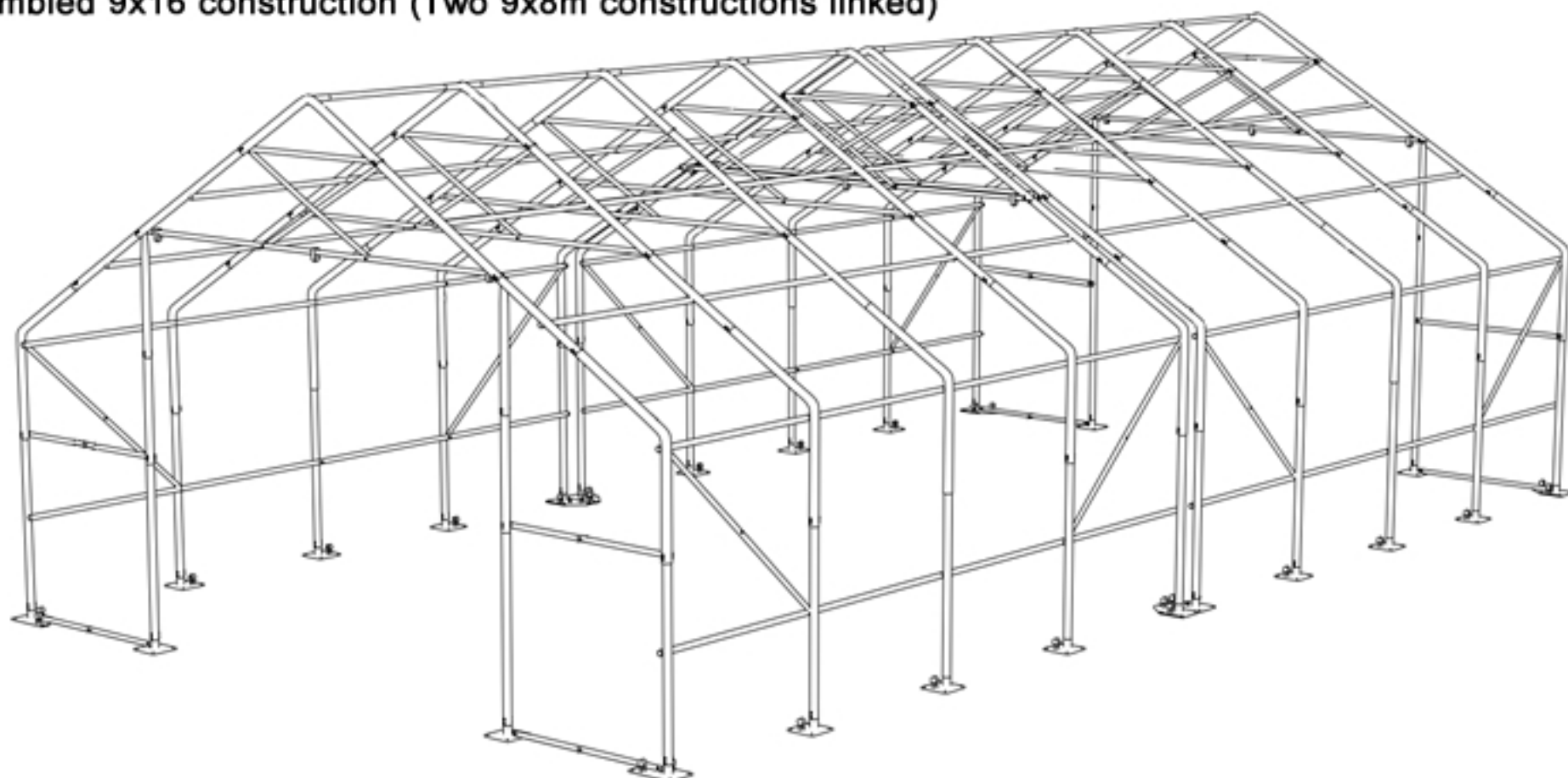

STEP 6

Distribute the tarpaulin along the wall of the tent. Transfer the tarpaulin through the whole length and width of the tent so it is possible to pull it to the pipes in the stitching using the lines. Make sure the tarpaulin is evenly distributed on each side. Remember that people on one side should pull and hold the tarpaulin so it can be easily moved on the steel construction on the other side.

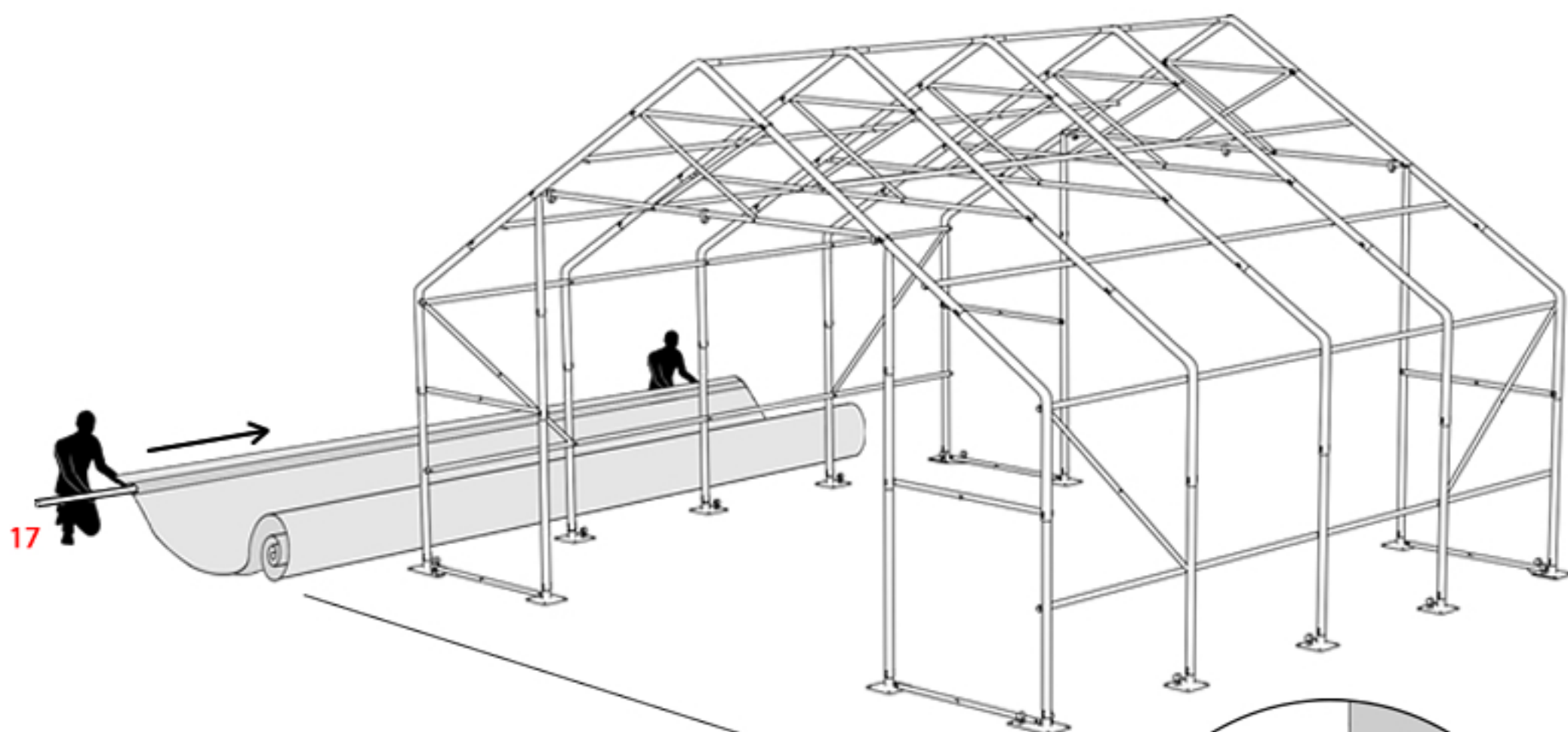

Before the distribution the tarpaulin should be stored in the temperature above 10 degrees Celsius. They should be distributed in such temperature (10 degrees Celsius or higher), otherwise it might crack on the bends.

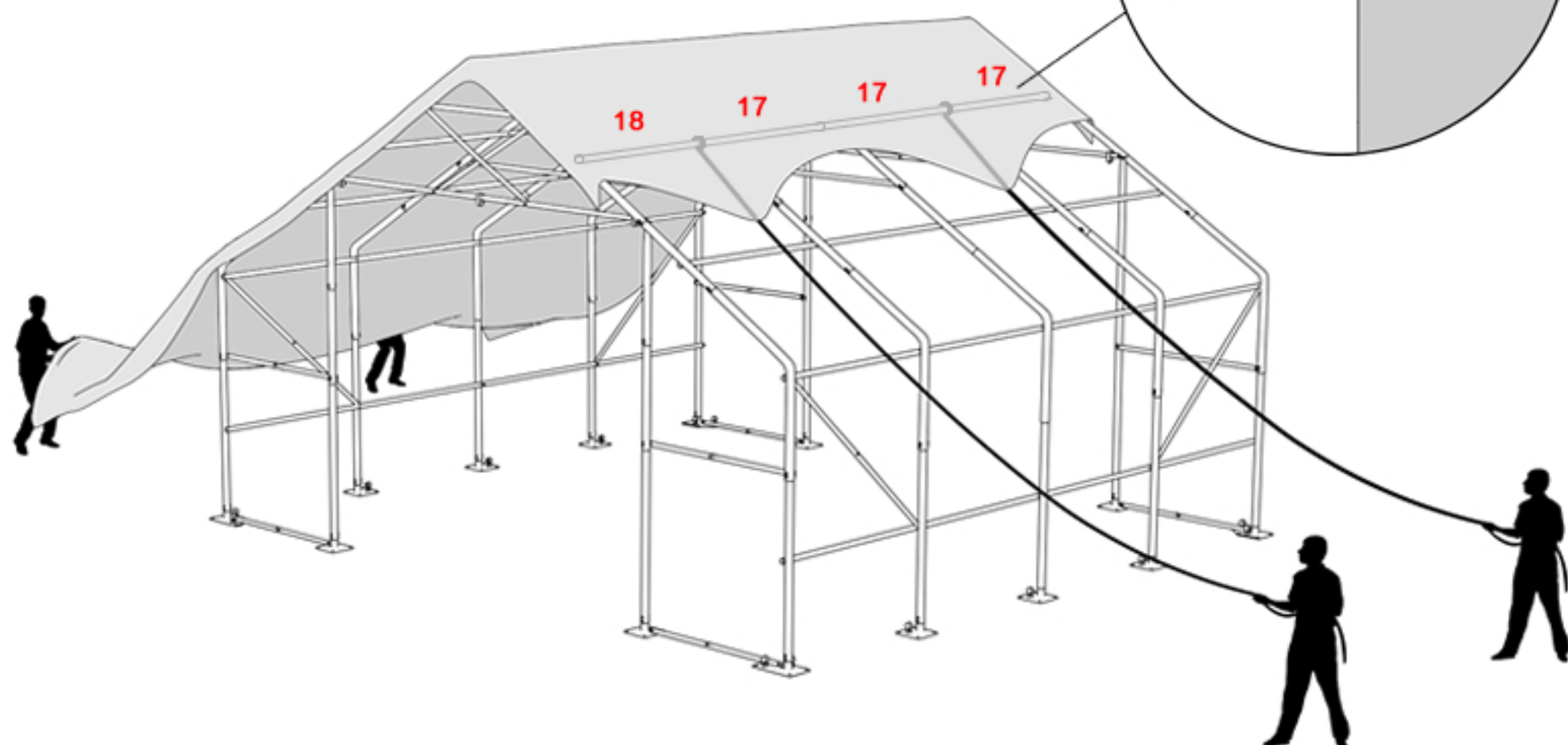
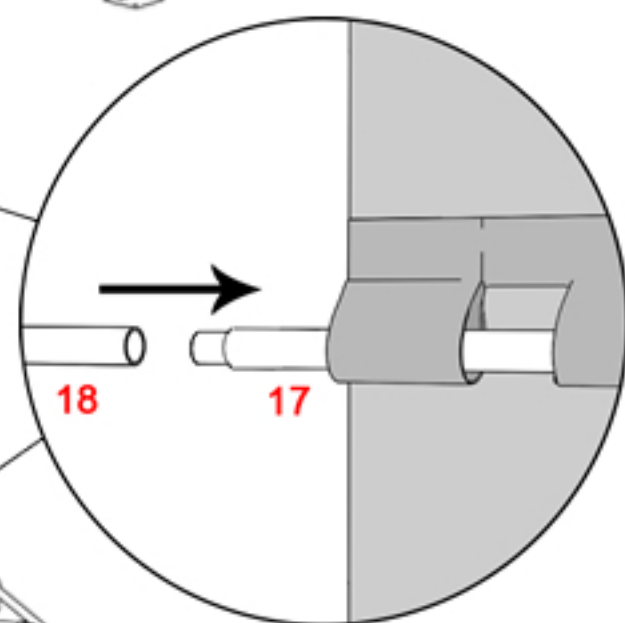

STEP 7

After the tarpaulin is in place, make sure all the pipes are placed in the stitching. Transfer belts through these tubes and pull on, hooking it on the buckle on the foot. Lock the buckle afterwards.

On the feet, transfer the belts through the tube and pull them, hooking them to the buckle located closer to the construction tube. Lock the buckle.

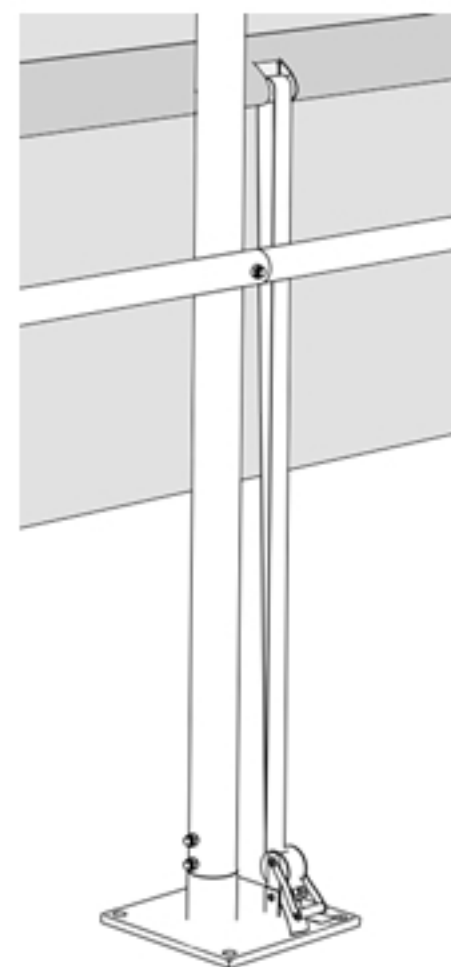

Fixed belt.

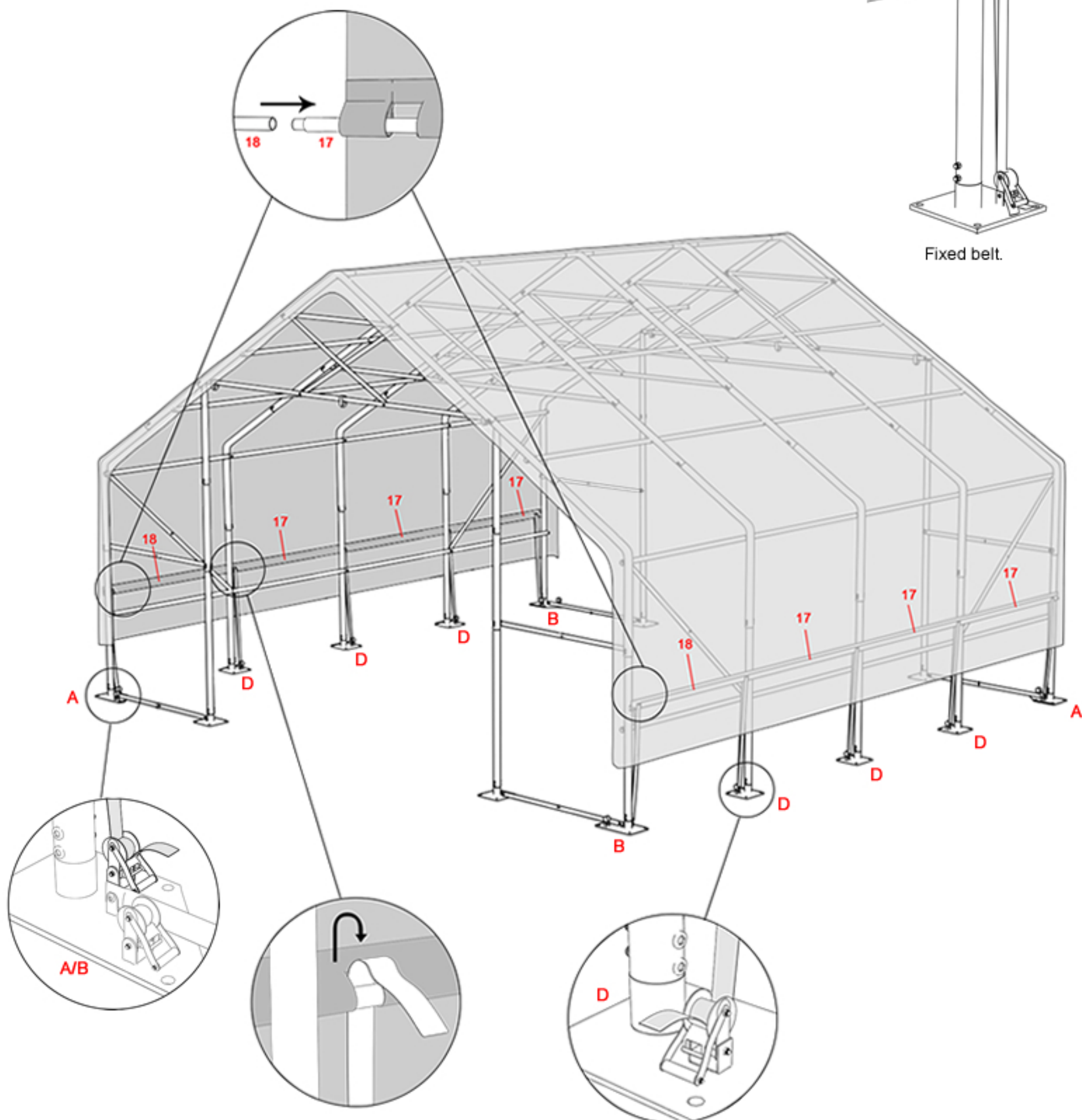

STEP 8

Pull the belt going through the tarpaulin on the entrances and hook it to the second buckle on the corner foot. Lock the buckle.

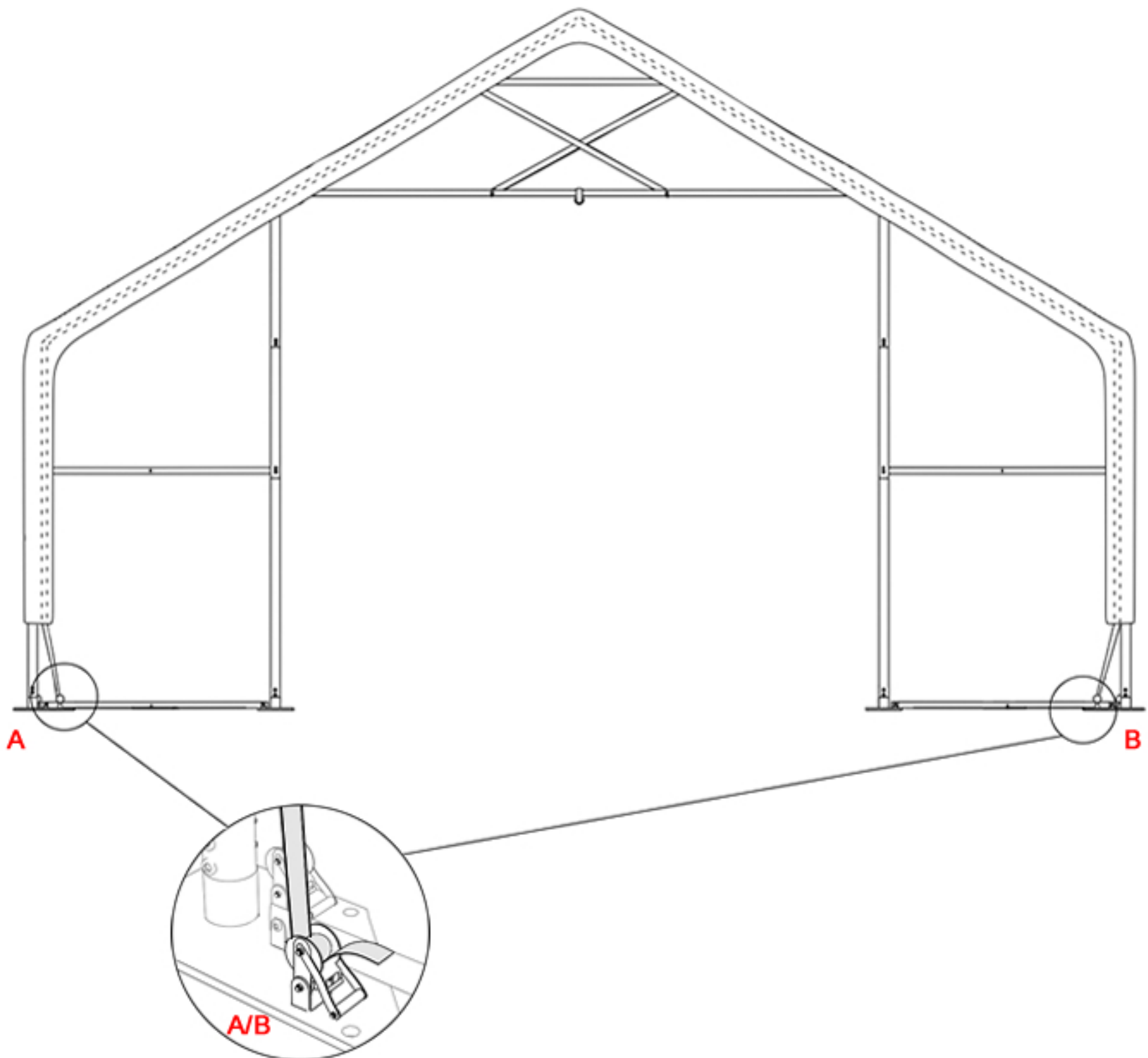

STEP 9

Fix tarpaulin extension on velcro.

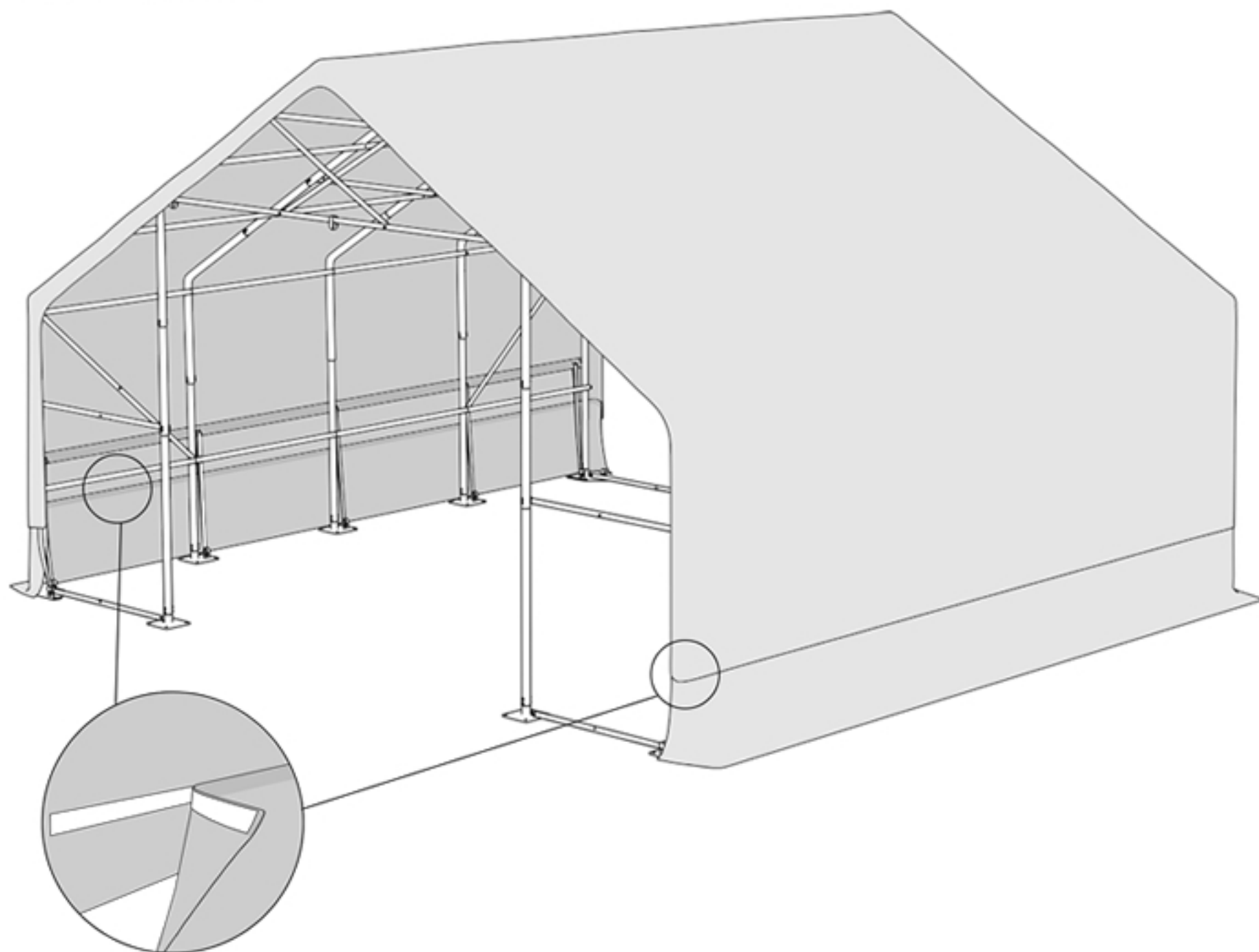

⚠ For the tents longer than 12m

Fix the gutter connecting two tents to the tarpaulin using balls with rubber.

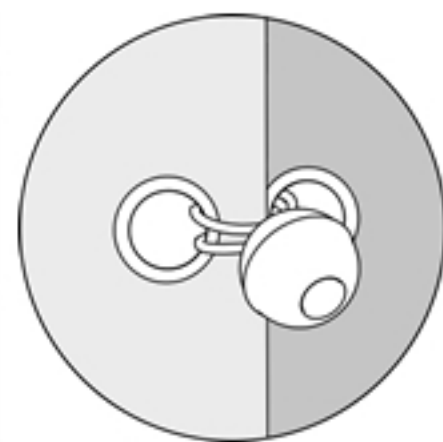
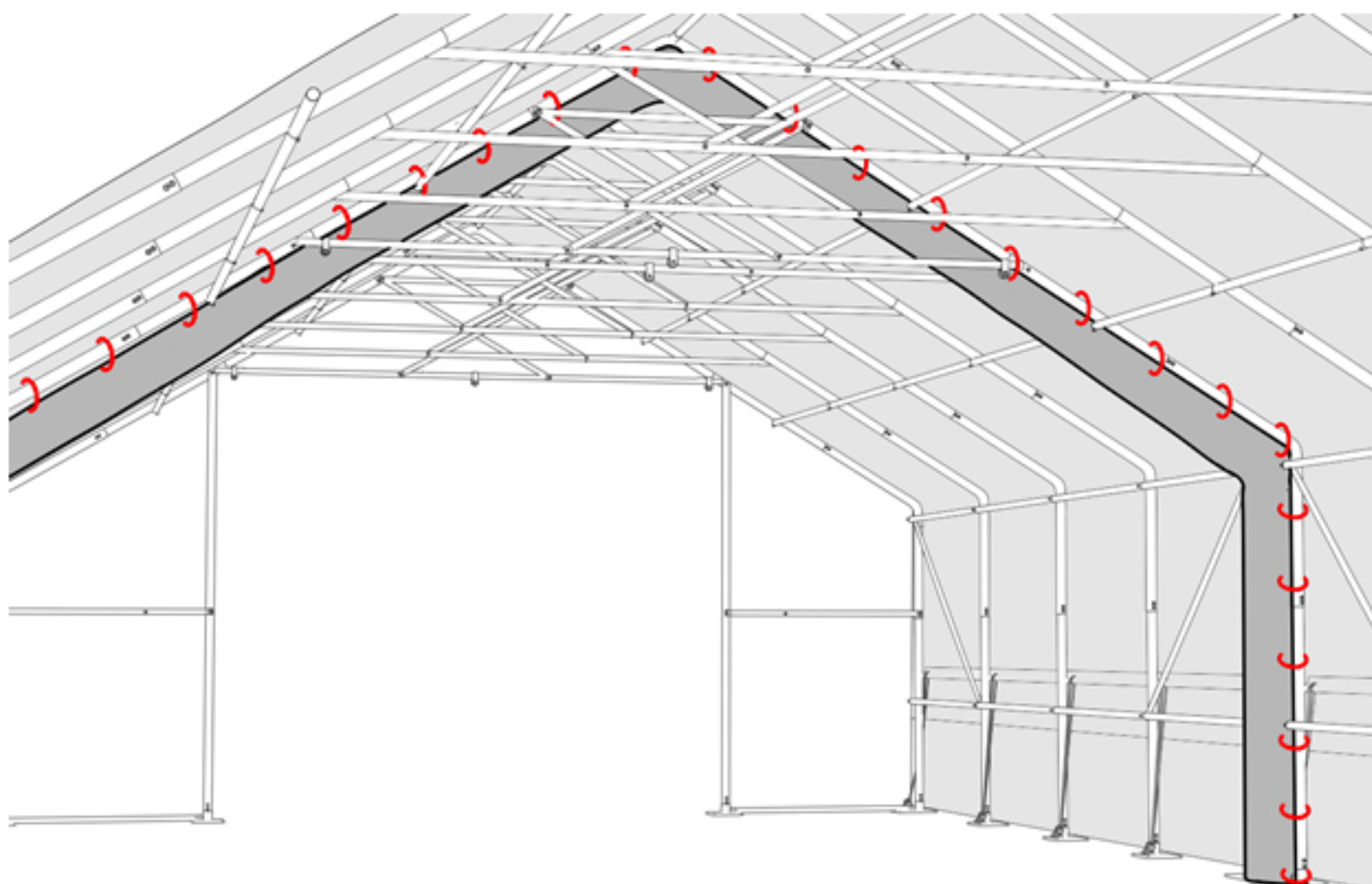

STEP 10**Entrance assembly**

Mount the entrance gate on the front and back frame.
Pull on the front cover by wrapping string on the rods and transferring the string through the holes in the tarpaulin.

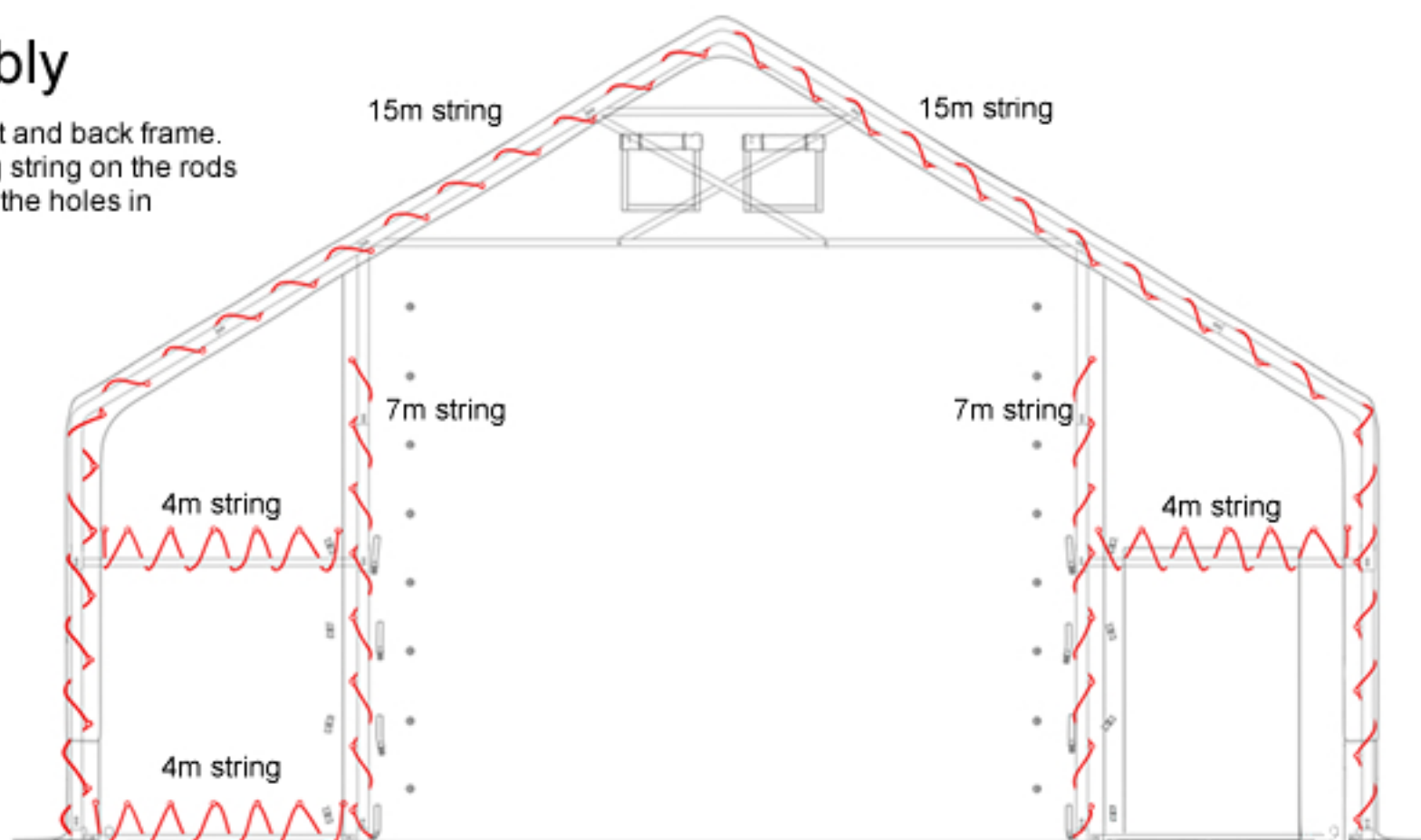
**STEP 11****Gate assembly**

Put tubes in the bottom pockets of the gate. Put 22m string in the gate holes on the left, under single reel (put the reel over the pipes). Pull the string through the reels along the gate to the double reel and again through the holes on the right side.

